

ORIGINAL VERSION



**ME REMOTE Electric Trolley
Instruction Manual**

EN



Before using this trolley for the first time, please take a few minutes to read through this manual to ensure that you get the most out of your purchase



REGISTER ONLINE
www.motocaddy.com/warranty

Visit www.motocaddy.com/instructions for other Motocaddy instructions including translations

SERIAL NUMBER LOCATION / DOWNHILL CONTROL

This Motocaddy electric trolley is designed for the transportation of golf bags and clubs contained within.

Locating the Serial Number

The serial number is located on the trolley underside next to the motors (fig. 1). This number is required when registering your warranty online and should be kept handy for future use.

The same number should also be on the box received with your trolley. If you need to return your trolley for any reason, please retain the packaging. A proof of purchase must also be kept in case your trolley requires servicing during its warranty period.



Fig 1

Please keep a record of your trolley serial number here for future reference:

--	--	--	--	--	--	--	--	--	--	--	--	--	--	--

Information about DHC (Downhill Control)

Downhill Control (DHC) technology allows the trolley to maintain a controlled speed whilst travelling down hills. Whenever you are looking to move the trolley in Manual Mode, even if just to reposition it, always put it on a low speed setting to make it easier to steer.

Equipment Overview

1. Power & Battery Indicators
2. On/Off & Speed Control Button
3. USB Port (underside of handle)
4. Upper Bag Support
5. Upper Release Latch
6. Charging Cable
7. Battery
8. Battery Tray
9. EASILOCK® Lower Bag Support
10. Front Wheels
11. Rear Wheels
12. Rear Wheel Release Buttons
13. Motors (under Battery Tray)
14. Auto-Open Stand
15. Lower Release Latch
16. Anti-Tip Rear Wheel (Required)
17. Anti-Tip Rear Wheel Release Button



SAFE USE OF YOUR TROLLEY

Safe use of your Trolley

The first time you use the trolley, we would advise using it on an open area of grass. The trolley speeds and steering characteristics will vary depending on the surface. The trolley will turn much quicker on hard, smooth surfaces and will behave differently on grass. You will also find that the weight of the golf bag will affect both speed and steering.

Motocaddy trolleys are designed for the transportation of golf bags and clubs contained within. Using the trolley for any other purpose may cause damage to the trolley and cause harm to the user. Caution and common sense should always be used.

- Never aim the trolley at other people or golf trolleys;
- When using the trolley in confined spaces (for example car parks) or near water (such as over bridges) it is advisable to use the 'Manual' control mode to ensure that you remain in control;
- Never let the trolley run out of your sight. Always use proper care and control;
- Do not attempt to transport any other equipment;
- The trolley is not designed for the transportation of people;
- The maximum rated load suitable for this trolley is 20kg;
- Do not use the trolley to assist you when walking up hills;
- Submerging the trolley in water (e.g. a lake) will cause damage to the trolley;
- Do not operate the trolley whilst under the influence of drugs or alcohol;
- This trolley can be used by children aged from 8 years and above and persons with reduced physical, sensory or mental capabilities if they have been given supervision or instruction concerning use of the trolley in a safe way and understand the hazards involved. Children shall not play with the trolley. Cleaning and user maintenance shall not be made by children without supervision;

Do not attempt to steer the trolley manually when being used in Remote Control mode. Motocaddy cannot take responsibility for any damage or injury caused from improper use.

Safety cut-out

This Motocaddy trolley is fitted with safety cut off features. Whilst operating the trolley via the remote control, if no command is sent to the trolley (any buttons pressed) for longer than 120 seconds, the trolley will stop. Whilst moving, if the trolley travels out of range of the remote control, the trolley will also cut power to the motors. Whilst operating the trolley in manual mode, if no adjustment to the speed is made via the dial for longer than 10 minutes, the trolley will stop. If any of these safety features initiate, pressing the 'On/Off' button or the "+" button of the remote handset will restart the trolley.

Caring for your Trolley

Although your Motocaddy trolley has been weatherproofed, please follow these simple guidelines to help protect your trolley:

- Do not store your trolley outside;
- Try to minimise exposure to rain as much as possible with an umbrella during heavy rainfall;
- Wipe excess water from the trolley prior to storage;
- Never use a pressure washer to clean your trolley. To prevent water damage, wipe down with a damp cloth;
- Avoid using high pressure air hoses near moving components;

This Motocaddy trolley is designed to require very little maintenance. We do however recommend checking your trolley before each use to ensure:

- There is no build up of excess mud and dirt;
- The rear wheels are securely fitted and turn freely;
- The rear wheel axles are greased and well lubricated;
- The front wheels are not clogged up and turn freely;

Only original Motocaddy parts should be used when repairing the trolley.

If you experience an issue with the trolley, please contact our Technical Support team for further assistance.

IMPORTANT BATTERY SAFETY & CARE

Important Battery Safety & Care Information

- Always recharge as soon as possible after finishing your round, regardless of the number of holes played - ideally within 12 hours. Leaving batteries uncharged for extended periods may reduce capacity and could pose a significant safety risk which could result in fire when the battery is charged. Batteries should always be fully charged prior to storing for long periods;
- Never leave batteries charging for longer than necessary - disconnect once the green LED light indicates the battery is fully charged;
- Ensure that only Motocaddy 28V Lithium batteries are charged with Motocaddy 28V Lithium battery chargers (Model **LC-2326**) and the charger is always connected to an earthed socket outlet;
- Batteries must be stored and charged on a dry, non-carpeted surface at a temperature ranging between 10°C and 30°C - charging outside these temperatures may reduce capacity;
- The battery and charger must only be opened and maintained by authorised personnel. Unauthorised opening increases the risk of safety issues and will invalidate your warranty;
- Take care not to drop the battery as this may cause damage to the internal cells which could affect battery performance and safety;
- Regularly check the battery for visible signs of damage. Do not charge or use the battery if any damage is suspected - contact our Technical Support team immediately for advice;
- Use a damp cloth to clean off any dirt, but try to avoid getting the battery too wet (i.e. do not submerge, avoid deep puddles & do not clean your trolley with the battery in the tray);
- **WARNING:** For the purposes of recharging the battery, only use the charger provided with this trolley;

- The battery supplied with this trolley contains battery cells that are non-replaceable;
- Only battery model 25.6V High Power ULTRA 230Wh can be used with this trolley;
- Exhausted batteries are to be removed from the trolley and safely disposed of;
- If the trolley is to be stored unused for a long period, the battery should be removed;
- The battery supply terminals must not to be short-circuited;

IMPORTANT - As with any electrical device, it is not recommended to leave batteries charging overnight or for prolonged periods without supervision. Motocaddy Lithium batteries can be fully-charged from empty in less than 5 hours, so wait for the charger light to turn green, switch off at the wall and unplug the battery ready for your next round.

WARNING - If the charger LED light flashes RED and/or GREEN consecutively when connected to the battery, this indicates there is likely to be a fault with the battery or charger. It is important that you disconnect the charger immediately and contact our support team for further assistance. Do not attempt to use the battery or charger as this could pose a significant safety risk which could result in fire.



We are dedicated to protecting the environment and encourage the recycling of Motocaddy products. Exhausted and damaged batteries should be safely disposed of through a local recycling point (where available). Alternatively, please contact our Customer Support team for further information regarding safe and responsible disposal.

CHARGING YOUR LITHIUM BATTERY

Charging your Lithium Battery

The Lithium battery can be left on the trolley or removed for charging. It is possible to charge the battery while the trolley is folded or unfolded. Always unplug the battery prior to folding the trolley or charging the battery.

1. Plug the Motocaddy 28V Lithium battery charger into an earthed mains power socket
2. The charger light will be GREEN when not attached to a battery to indicate that it is ready to charge
3. Attach the battery cable to the charger matching the black and blue connections
4. The charger light will provide an indication of charging phase:

 RED - Battery charging   GREEN - Battery fully charged and ready to be disconnected

5. The charging process will take between 3 to 5 hours depending on the depth of discharge.
This may take longer for the first few charges
6. Once charging is complete, disconnect the charger from the mains power supply and battery

WARNING - If the charger LED light flashes RED and/or GREEN consecutively when connected to the battery, this indicates there is likely to be a fault with the battery or charger. It is important that you disconnect the charger immediately and contact our support team for further assistance. Do not attempt to use the battery or charger as this could pose a significant safety risk which could result in fire.

Recommendations for hibernation of Lithium Batteries during winter months

If for any reason your Lithium battery is not going to be used for lengthy periods, e.g. 3-months over the winter, the battery should be stored fully charged. Before the battery is used again, recharge it (top it up) prior to use. The battery must not be left for longer than 2-months without charging as this could invalidate your warranty.

We recognise that extended absences are not always planned in advance, however when it is likely that you will not be using your battery for a period of time it is good practice to follow these steps to extend the life of your Lithium battery. Always recharge as soon as possible after finishing your round, regardless of the number of holes played - ideally within 12 hours. Leaving batteries uncharged for extended periods may reduce capacity and could pose a significant safety risk which could result in fire when the battery is charged. Batteries should always be fully charged prior to storing for long periods. Please ensure that the charger is ALWAYS disconnected from the battery after charging.

Battery Management System (BMS)

Motocaddy Lithium batteries are fitted with a comprehensive battery management system (BMS) to protect the battery from excessive abuse, high currents, deep discharge and overcharge. When the battery is delivered there may be no output as the BMS is designed to maximize safety whilst shipping. Please ensure that the battery is fully charged prior to connecting it to your trolley as this will activate the BMS and effectively 'switch-on' the battery. From time to time, at deep discharge or long term storage the BMS may switch-off the battery. A full battery charge will rectify this problem.

Motocaddy golf trolleys are designed to work with the BMS system installed in the Lithium batteries and the battery meter is also synchronised to work in conjunction with the battery. If for any reason the voltage on the battery falls below the low battery warning on the trolley, then the BMS may disable the battery to protect it. Again if this occurs please recharge fully. Please be aware that Lithium batteries tend to 'drop off' quickly at the end of the cycle so it is not advisable to attempt to play excessive holes as the BMS will activate for protection purposes.

ATTACHING THE WHEELS / INVERTING THE WHEELS

Attaching the Wheels

This trolley does not have a specific left and right wheel. To attach the rear wheels:

1. Push and hold the quick release button in towards the centre of the wheel
2. Slide the wheel onto the trolley axle as far as it will go (onto the inner groove)
3. Once in position, release the button and pull the wheel outwards slightly to lock
4. An audible 'click' will confirm the wheel is in the correct position

Once correctly attached onto the inner groove, the rear wheels will not rotate freely in either direction.

The outer groove can be used as a "free-wheel" option if you run out of battery power. Slide the wheel onto the outer groove and pull the wheel outwards slightly to lock. Once connected, the wheel will spin freely without resistance in both directions.

Inverting the Wheels

The rear wheels can be inverted to reduce the trolley width for transportation and storage.

1. Push and hold the quick release button while sliding the wheel off the axle
2. Flip the wheel over, push and hold the button, then slide onto the axle
3. Release the button and pull the wheel out slightly until it engages with the free wheel groove

It is important the wheels are not pushed on too far. They should not touch the chassis.

Attaching the Anti-Tip Wheel (Required)

The Anti-Tip wheel is designed to prevent the trolley from tipping backwards on steeper inclines and it is recommended that the wheel is ALWAYS fitted when navigating using the remote control handset.

To attach the wheel, pull the grey button on the right-hand side out and slide the wheel attachment into the housing. There will be a 'click' when the wheel is securely fitted.

To remove the wheel, pull the grey button out and slide the attachment out of the housing.

The Anti-Tip wheel can be removed for cleaning and storage purposes.



USB Charging Port

This trolley features a USB charging port designed to charge USB powered devices during your round.

Remove the covering cap and plug a USB cable into the charging port located on the underside of the handle. The device will continue charging while the cable is attached and the battery is connected.

The rate of charge will be slower than a mains AC charger and similar to plugging the device into a PC. The USB charger takes power from the main trolley battery and continuous charging will reduce the battery capacity between charges. The trolley is designed to disable the USB port when the battery capacity reaches a preset level.

Unfolding your Trolley

We recommend unfolding your trolley once the wheels have been un-inverted and re-attached (see page 10).

1. Lift the upper bag support slightly and release the upper latch (fig. 1)
2. Unfold the handle and re-secure the latch (fig. 2)
3. Release the lower latch (fig. 3)
4. Lift the trolley handle up into position (fig. 4). The front wheel will automatically unfold
5. Re-secure the lower latch and ensure the auto-open stand is folded away (fig. 5)
6. Insert anti-tip wheel (see page 13)



Fig 1



Fig 2



Fig 3

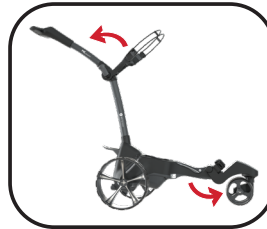

Fig 4



Fig 5

Folding your Trolley

1. Release the lower latch (fig. 1). The auto-open stand will also be activated
2. Fold the frame forward until fully extended (fig. 2). The front wheel will automatically fold underneath
3. Release the upper latch and fold the handle back until the trolley is fully folded (fig. 3)
4. Re-secure both latches. If you wish to stand the trolley upright, leave the auto-open stand out. Remember to ensure the auto-open stand is pushed down if not being used (fig. 4)
5. The wheels can be inverted to reduce the trolley width for transportation and storage (fig. 5). See page 10 for details

Please ensure the auto-open stand is folded away when not in use to prevent damage. The anti-tip wheel will need to be removed if you are planning on standing the trolley upright for storage.



Fig 1

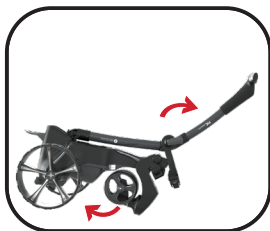

Fig 2



Fig 3



Fig 4



Fig 5

LOWER BAG SUPPORTS

Lower Bag Support with EASILOCK® Bag

All Motocaddy trolleys are fitted with the EASILOCK® bag attachment system. This securely attaches the bag, reduces twisting and removes the need to use a lower bag strap.

1. If using an EASILOCK® compatible bag, please ensure that the supplied pins are fitted to the bag base (fig. 1)
2. If attached, remove the two lower bag support elastic straps by pressing and holding the back of the clip before pulling outwards (fig. 2)
3. Align the cut out on the bag base with the lower bag support platform to align the bag pins with the holes on the trolley (fig. 3)
4. Lower the bag until the pins locate with the two holes. You should hear a positive “CLICK” as the bag locks into position

Lower Bag Support with Non-EASILOCK® Bag

If you are using a non-EASILOCK® golf bag, please do not remove the two lower bag support elastic straps:

1. Position your bag so it is resting on the lower bag support platform and in the cradle of the upper bag support
2. Stretch the lower bag strap around the bag base and loop the rounded bar underneath the bag support hook (fig. 4)

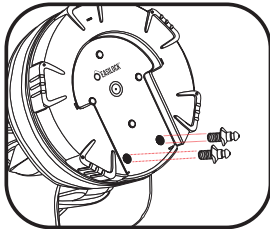

Fig 1

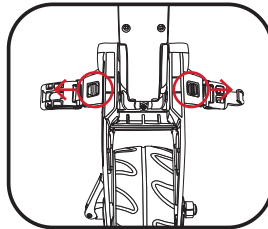

Fig 2

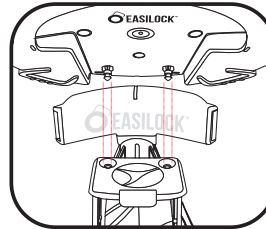

Fig 3

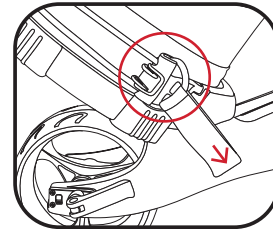

Fig 4

Upper Bag Supports

The upper bag support straps are secured in the same way as the lower straps using the following steps:

1. Stretch the elasticated strap around the bag & loop the rounded bar underneath the hook (fig. 1)
2. Position the two placement straps centrally on your golf bag (fig. 2)

Adjusting the Bag Supports

The bag support straps are manufactured from elasticated material to allow your golf bag to be held tightly in position. The strap should be adjusted to be reasonably tight around the golf bag:

1. Unclip the elasticated straps from the housing by pulling outwards in the direction shown (fig. 3)
2. Move the bar as required to tighten or loosen the strap fitting. Pulling the bar downwards will tighten, upwards will loosen (fig. 4)
3. Ensure that the straps are clipped back into the housing before use (fig. 5)

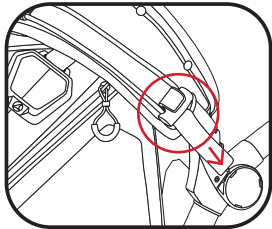

Fig 1

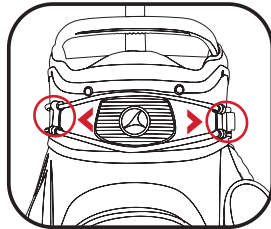

Fig 2

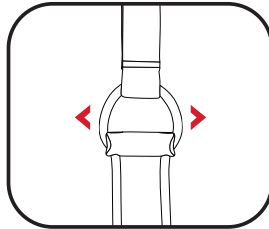

Fig 3

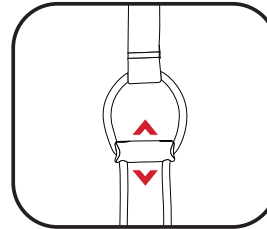

Fig 4

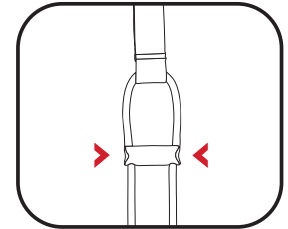

Fig 5

REMOTE CONTROL HANDSET

Remote Control Handset

1. Indicator LED
2. Plus (+) Button
3. Stop Button
4. Left (<) Button
5. Right (>) Button
6. Minus (-) Button
7. On/Off & Lock Button
8. Charging Port

The remote handset contains a rechargeable Lithium battery. The handset can be recharged using a mini USB cable (supplied), the charging port is located under the rubber flap at the base of the handset.

The green LED on the handset will flash whilst being charged, once it is fully charged the green LED will be on and not flashing. This will take around 4-5 hours from empty.

When the handset battery starts to get low, the LED will flash red when pressing a button. Should the battery go completely flat there will be no LED when pressing a button. Should this happen, the trolley will stop. You can recharge the handset using the USB port on the trolley.

Please be aware that charging the remote handset through the USB port will take power from the main trolley battery and prolonged charging will reduce the trolley battery capacity between charges.

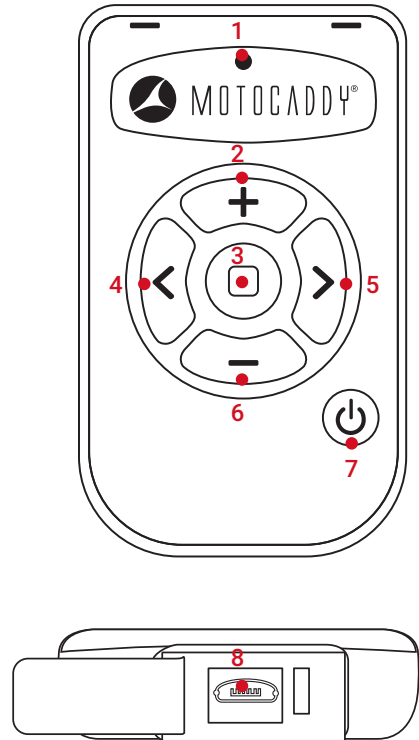

Pairing the Remote Control

In the event that the remote is not responding or you have a new handset, it will need to be paired to the trolley:

1. Press and hold the 'Stop' button on the remote handset for 5 seconds (fig. 1a)
2. The LED on the handset will start flashing green (fig. 1b), at this point release the button and connect the battery to the trolley
3. If the trolley is not powered on within 60 seconds, the handset will exit pairing mode

Handset Lock Function

The remote handset can be locked by pressing the 'Lock' button (fig. 2a), when this is pressed the LED will either flash green or red (fig. 2b). Green indicates that the handset is unlocked and red indicates locked.

When it is locked the directional buttons will be disabled and a red LED will flash when they are pressed, the 'Stop' button will still operate and show a green LED when pressed.

If the handset is locked whilst the trolley is running in remote mode, the trolley will stop after 4 seconds as the handset will stop sending a signal. If the trolley is in Manual Mode it will continue to run but can still be stopped using the 'Stop' button on the handset.

Pressing the 'Lock' button again (fig. 2a) so the LED flashes green (fig. 2b), will unlock the handset and all buttons will be enabled.

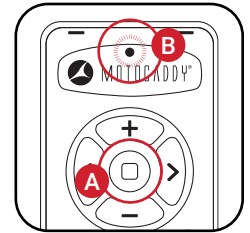

Fig 1

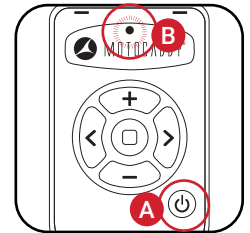

Fig 2

OPERATING IN REMOTE MODE

Operating using the Remote Control Handset

When the battery is first plugged in to the trolley, the speed will default to 2. This is the speed that the trolley will always start at after it has been stopped.

To start the trolley, press the "+" (Plus) button on the remote control handset. The "+" (Plus) and "-" (Minus) buttons can then be used to increase and decrease the speed to the required pace.

The "<" (Left) and ">" (Right) buttons are used to steer the trolley, a quick press of the button will adjust the direction slightly at the current speed, a longer press of the left and right buttons will reduce the speed to turn the trolley, it will gradually increase the sharpness of the turn the longer the button is held. Release the button and the trolley will return to the original speed it was going.

The trolley can be stopped quickly by pressing the stop button or gradually by decreasing the speed until it stops. The lowest speed setting in remote mode is 2. Reducing the speed further will stop the trolley.

When the trolley is stationary, pressing and holding the "-" (Minus) button will put the trolley into reverse. Releasing the "-" (Minus) button will stop the trolley. The trolley will only reverse at one speed and cannot be steered whilst reversing.

It is recommended to fully-charge the remote control handset before each round of golf to optimise remote performance. The range of the remote control handset can be affected by a number of factors including signal strength, weather conditions, remote battery capacity and radio frequency interference.

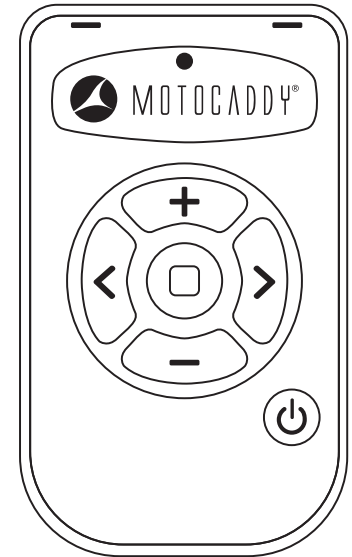

Switching to Manual Mode

The trolley can also be used in Manual Mode, allowing it to be controlled from the handle without the remote handset.

While the trolley is stationary, press the 'On/Off' button to start the trolley and turn the dial to select the desired speed. You can also switch to Manual Mode whilst the trolley is moving. Turn the speed dial and the trolley will respond to the selected speed.

You can switch back to Remote Mode by pressing the "+" (Plus), "<" (Left) or ">" (Right) buttons, it can also be stopped with the 'Stop' button. Pressing the "-" (Minus) button will decrease the speed but will leave the trolley in Manual Mode.

Operating in Manual Mode

The main 'On/Off' button is used to start and stop the trolley, whilst also controlling the speed, which can be adjusted while the trolley is in motion.

The trolley has 9 speed settings (1 to 9) with 1 being the slowest and 9 the fastest. To increase the speed, rotate the 'On/Off' button clockwise, or anti-clockwise to decrease the speed.

To start the trolley, press the 'On/Off' button and select the required speed setting. The trolley will smoothly accelerate until it reaches the selected speed. The left hand LED will flash (fig. 1) to indicate that the trolley is in motion.

To stop the trolley, simply press the 'On/Off' button again - there is no need to reduce the speed setting. The speed setting will automatically reset to speed 2 when the trolley is stopped.



Fig 1

SETTING THE TROLLEY TO RUN STRAIGHT

Adjusting the Front Wheel Alignment

If your trolley is not running in a straight line, there are a couple of adjustments that can be made. The problem can be caused by a number of factors including a slightly loose bag support or unevenly packed bag. The first thing to alter is the front wheel alignment:

1. Place the trolley on a flat level surface and ensure that you are using remote mode
2. Rotate the front wheels 180° to allow access to the quick-release lever (fig. 1) and pull down the quick-release lever (fig. 2)
3. There are two small metal dials on either side of the housing that are used to realign the wheel (fig. 3)
4. If your trolley is veering to the right, you will need to turn the left hand dial clockwise and the right hand dial anti-clockwise
5. If your trolley is veering to the left, you will need to turn the right hand dial clockwise and the left hand dial anti-clockwise
6. Push the quick release lever back up until it firmly clips in to place (fig. 4)
7. Rotate the wheel back 180° so that it sits underneath the housing (fig. 5)

This procedure can be carried out until the trolley is moving in a straight line (you may only need to adjust one dial at a time).

These instructions are based on being in front of the trolley looking at the wheel whilst it is in front of the housing.



Fig 1



Fig 2



Fig 3



Fig 4



Fig 5

Motor Trimming

If the trolley is now running straight in Remote Mode but not in Manual Mode, the motors will need trimming:

1. Place the trolley on a flat, level surface and ensure the trolley is stationary and the battery is connected
2. Press and hold the 'On/Off' button for 3 seconds until the handle LED indicators flash green
3. Turning the 'On/Off' button anti-clockwise will trim the trolley left (left LED flashes) and turning the button clockwise will trim the trolley right (right LED flashes). The flashing intensifies as the trim amount increases
4. Once the required trim amount has been selected, press 'On/Off' to return to normal operation
5. Check the trolley is now running in a straight line and repeat steps 1 to 4 if further adjustment is required

It is recommended to start trimming gradually and then increase if necessary.

Motor Trimming will only affect trolley direction in Manual (non-remote) Mode. It is strongly recommended to adjust the front wheel alignment before continuing with Motor Trimming.

Power & Battery Indicators

There are two indicating LEDs above the 'On/Off' button. The left hand LED (fig. 1) illuminates green when the battery is plugged in and the power is on. It will flash when the trolley is in motion. The right hand LED (fig. 2) displays battery capacity (green, amber and red) and will illuminate when the battery is plugged in.

The battery indicator will only accurately display the battery status while the trolley is stationary. When the trolley is moving and under varying loads, the battery indicator may occasionally show excessively low readings.

The trolley is designed to protect the battery from being fully discharged. Should the battery capacity drop too low, the trolley will cut power to the motor and the battery indicator LED will flash red (fig. 3).

Please charge your battery before further use.



Fig 1



Fig 2



Fig 3

IC STATEMENT

IC Statement

This device contains licence-exempt transmitter(s)/receiver(s) that comply with Innovation, Science and Economic Development Canada's licence-exempt RSS(s). Operation is subject to the following two conditions:

- (1) This device may not cause interference
- (2) This device must accept any interference, including interference that may cause undesired operation of the device

l'appareil contient des émetteurs/récepteurs exempts de licence qui sont conformes aux CNR exempts de licence d'Innovation, Sciences et Développement économique Canada. L'exploitation est soumise aux deux conditions suivantes:

- (1) l'appareil ne doit pas produire de brouillage
- (2) l'utilisateur de l'appareil doit accepter tout brouillage radioélectrique subi, même si le brouillage est susceptible d'en compromettre le fonctionnement. The user manual for local area network devices shall contain instructions related to the restrictions mentioned in the above sections, namely that:
 - (i) the device for operation in the band 5150-5250 MHz is only for indoor use to reduce the potential for harmful interference to co-channel mobile satellite systems
 - (ii) the maximum antenna gain permitted for devices in the bands 5250-5350 MHz and 5470-5725 MHz shall comply with the e.i.r.p. limit; and
 - (iii) the maximum antenna gain permitted for devices in the band 5725-5825 MHz shall comply with the e.i.r.p. limits specified for point-to-point and non point-to-point operation as appropriate
- (i) Les dispositifs fonctionnant dans la bande 5150-5250 MHz sont réservés uniquement pour une utilisation à l'intérieur afin de réduire les risques de brouillage préjudiciable aux systèmes de satellites mobiles utilisant les mêmes canaux
- (ii) le gain d'antenne maximal autorisé pour les appareils dans les bandes 5250-5350 MHz et 5470-5725 MHz doivent respecter le pire limiter; et
- (iii) le gain d'antenne maximal autorisé pour les appareils dans la bande 5725-5825 MHz doivent respecter le pire limites spécifiées pour le point-à-point et l'exploitation non point à point, le cas échéant.

Users should also be advised that high-power radars are allocated as primary users (i.e. priority users) of the bands 5250-5350 MHz and 5650-5850 MHz and that these radars could cause interference and/or damage to LE-LAN devices.

Les utilisateurs de radars de haute puissance sont désignés utilisateurs principaux (c.-à-d., qu'ils ont la priorité) pour les bandes 5250-5350 MHz et 5650-5850 MHz et que ces radars pourraient causer du brouillage et/ou des dommages aux dispositifs LAN-EL.

IC Radiation Exposure Statement:

Cet équipement a été mis à l'essai et respecte les limites applicables pour l'exposition aux radiofréquences (RF). La limite d'IC SAR pour le SAR des extrémités est de 4,0 W/kg (10 g) et le SAR corporel est de 1,6 W/kg (1 g). La valeur SAR la plus élevée déclarée en vertu de cette norme lors de la certification du produit lorsqu'il est correctement porté par un membre (0 mm) à l'extrémité SAR est de 0.98W / kg, et près du corps (0 mm) SAR est de 1.30W / kg.

FCC Statement

This device complies with Part 15 of the FCC Rules. Operation is subject to the following two conditions:

- (1) This device may not cause harmful interference, and
- (2) This device must accept any interference received, including interference that may cause undesired operation.

Changes or modifications not expressly approved by the party responsible for compliance could void the user’s authority to operate the equipment.

FCC Radiation Exposure Statement:

This equipment has been tested and meets applicable limits for radio frequency (RF) exposure. The FCC SAR limit for extremity SAR is 4.0W/kg (10g) and Body SAR is 1.6W/kg (1g). The highest SAR value reported under this standard during product certification when properly Limb worn (0mm) on the extremity SAR is 0.90 W/kg, and close to body(0mm) SAR is 1.10W/kg.

The device has been evaluated to meet general RF exposure requirement. The device can be used in portable exposure condition without RF striction.

NOTE: This equipment has been tested and found to comply with the limits for a Class B digital, pursuant to Part 15 or the FCC Rules.

These limits are designed to provide reasonable protection against harmful interference in a residential installation. This equipment generates, uses and can radiate radio frequency energy and, if not installed and used in accordance with the instructions, may cause harmful interference to radio communications. However, there is no guarantee that interference will not occur in a particular installation. If the equipment does cause harmful interference to radio or television reception, which can be determined by turning the equipment off and on, the user is encouraged to try to correct the interference by one or more of the following measures:

- (1) Reorient or relocate the receiving antenna
- (2) Increase the separation between the equipment and receiver
- (3) Connect the equipment into an outlet on a circuit different from that to which the receiver is connected
- (4) Consult the dealer or an experienced radio/TV technician for help





 Motocaddy Ltd,
Units 15 - 18 Stansted Distribution Centre,
Start Hill, Great Hallingbury, Hertfordshire, CM22 7DG,
United Kingdom

 +44 (0)1279 712 370

 info@motocaddy.com

 www.motocaddy.com

MC.25.153.001

EASILOCK® Patent (GB) - GB2519073 | USB Charging Port Patent (GB) - GB2473845 | USB Charging Port Patent (AUSTRALIA) - 2010224448